

TS0046UK05

# RS Series

## Two Stage Progressive Gas Burners

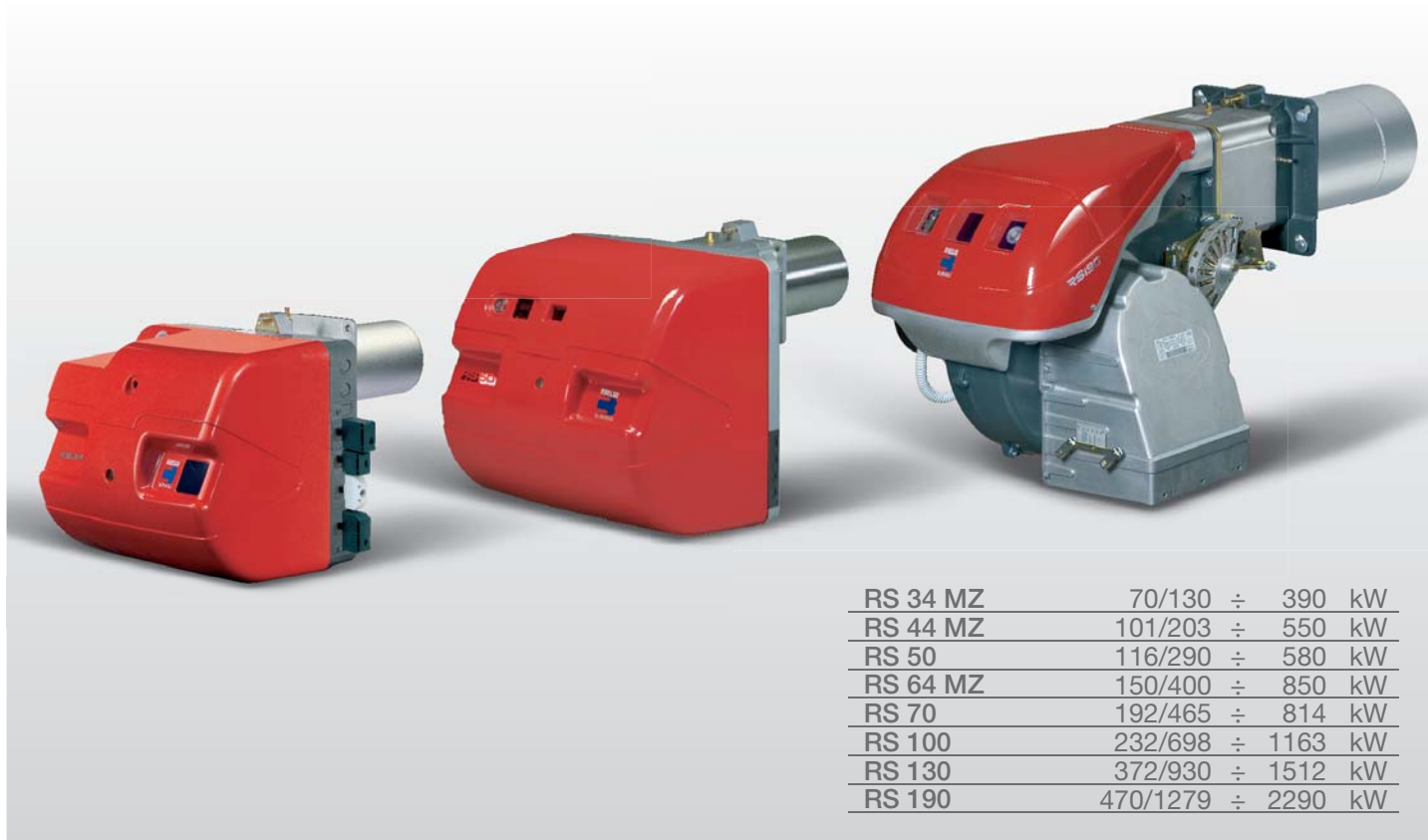

The RS burners series covers a firing range from 70 to 2290 kW, and it has been designed for use in low or medium temperature hot water boilers, hot air or steam boilers, diathermic oil boilers.

Operation is "two stage progressive"; the burners are fitted with a microprocessor control panel which supplies indication of operation and diagnosis of fault cause.

The elevated performance of the fans and combustion head, guarantee flexibility of use and excellent working at all firing rates.

The exclusive design ensures reduced dimensions, simple use and maintenance. A wide range of accessories guarantees elevated working flexibility.

**Technical Data**

MODEL		RS 34 MZ	RS 44 MZ	RS 50	RS 64 MZ
Burner operation mode		Two stage progressive			
Modulation ratio at max. output		2 ÷ 1			
Servomotor	type	SQN90			
	run time s	12			
Heat output	kW	70/130÷390	101/203÷550	116/290÷581	150/400÷850
	Mcal/h	60/112÷335	87/175÷473	100/249÷500	129/344÷731
Working temperature	°C min./max.	0/40			
<b>FUEL/AIR DATA</b>					
Net calorific value G20 gas	kWh/Nm <sup>3</sup>	10			
Density gas G20	kg/Nm <sup>3</sup>	0,71			
Output gas G20	Nm <sup>3</sup> /h	7/13÷39	10/20÷55	11,6/29÷58	15/40÷85
Net calorific value G25 gas	kWh/Nm <sup>3</sup>	8,6			
Density gas G25	kg/Nm <sup>3</sup>	0,78			
Output gas G25	Nm <sup>3</sup> /h	8/15÷45	12/24÷64	13,5/34÷68	17/47÷99
Net calorific value LPG gas	kWh/Nm <sup>3</sup>	25,8			
Density LPG gas	kg/Nm <sup>3</sup>	2,02			
Output LPG gas	Nm <sup>3</sup> /h	3/5÷15	4/8÷21	4,5/11÷23	6/16÷33
Fan	Type	(02)	(02)	(01)	(02)
Air temperature	Max. °C	60			
<b>ELECTRICAL DATA</b>					
Electrical supply	Ph/Hz/V	(04)	(04)	(06)	(05)
Auxiliary electrical supply	Ph/Hz/V	(04)	(04)	(03)	(03)
Control box	Type	RMG			
Total electrical power	kW	0,6	0,7	0,8	0,75
Auxiliary electrical power	kW	0,3	0,28	0,35	0,12
Protection level	IP	40	40	44	40
Motor electrical power	kW	0,3	0,42	0,45	0,65
Rated motor current	A	3,2	3,5	2 - 1,4	3 - 1,7
Motor start current	A	15	17	14 - 10	13,8 - 8
Motor protection level	IP	40	40	54	40
Ignition transformer	V1 - V2	230V-1x15 kV	230V-1x15 kV	230V-1x8 kV	230V-1x15 kV
	I1 - I2	1A - 25 mA	1A - 25 mA	1A - 20 mA	1A - 25 mA
Operation		Intermittent (at least one stop every 24 h)			
<b>EMISSIONS</b>					
Sound pressure	dB(A)	70	72	72	76
Sound output	W	--			
CO Emission	mg/kWh	< 40			
NOx Emission	mg/kWh	< 120	< 120	< 130	< 120
<b>APPROVAL</b>					
Directive		90/396 - 89/336 (2004/108) - 73/23 (2006/95) - 92/42 EC			
Conforming to		EN 676			
Certification		CE 0085BR0381	CE 0085BR0381	CE 0085AP0735	in progress

- (01) Centrifugal with reverse curve blades  
(02) Centrifugal with forward curve blades  
(03) 1/50/230-(±10%)  
(04) 1/50-60/220-230-(±10%)  
(05) 3/50/230-400-(±10%)  
(06) 3/50-60/220-400-(±10%)

**Reference conditions:**

Temperature: 20°C - Pressure: 1013,5 mbar - Altitude: 0 m a.s.l. - Noise measured at a distance of 1 meter.

Since the Company is constantly engaged in the production improvement, the aesthetic and dimensional features, the technical data, the equipment and the accessories can be changed. This document contains confidential and proprietary information of RIELLO S.p.A. Unless authorised, this information shall not be divulged, nor duplicated in whole or in part.

MODEL		RS 70	RS 100	RS 130	RS 190
Burner operation mode		Two stage progressive			
Modulation ratio at max. output		2 ÷ 1			
Servomotor	type	LKS210		SQN31	
	run time s	15			
Heat output	kW	192/465÷814	232/698÷1163	372/930÷1512	470/1279÷2290
	Mcal/h	165/400÷700	200/600÷1000	320/800÷1300	405/1100÷1970
Working temperature	°C min./max.	0/40			
<b>FUEL/AIR DATA</b>					
Net calorific value G20 gas	kWh/Nm <sup>3</sup>	10			
Density gas G20	kg/Nm <sup>3</sup>	0,71			
Output gas G20	Nm <sup>3</sup> /h	19/46,5÷81,4	23/70÷116	37/93÷151	47/128÷229
Net calorific value G25 gas	kWh/Nm <sup>3</sup>	8,6			
Density gas G25	kg/Nm <sup>3</sup>	0,78			
Output gas G25	Nm <sup>3</sup> /h	22/54÷95	27/81÷135	43/108÷176	55/149÷266
Net calorific value LPG gas	kWh/Nm <sup>3</sup>	25,8			
Density LPG gas	kg/Nm <sup>3</sup>	2,02			
Output LPG gas	Nm <sup>3</sup> /h	7,4/18÷32	9/27÷45	14,4/36÷59	18/50÷89
Fan	Type	(01)	(01)	(01)	(02)
Air temperature	Max. °C	60			
<b>ELECTRICAL DATA</b>					
Electrical supply	Ph/Hz/V	3/50/230-400~(±10%)			
Auxiliary electrical supply	Ph/Hz/V	1/50/230 ~ (±10%)			
Control box	Type	RMG			
Total electrical power	kW	1,4	1,8	2,6	5,5
Auxiliary electrical power	kW	0,3	0,3	0,4	1
Protection level	IP	44			
Motor electrical power	kW	1,1	1,5	2,2	4,5
Rated motor current	A	4,8 - 2,8	5,9 - 3,4	8,8 - 5,1	15,8 - 9,1
Motor start current	A	25 - 14,6	27,7 - 16	57,2 - 33,2	126 - 73
Motor protection level	IP	54			
Ignition transformer	V1 - V2	230V - 1x8 kV			
	I1 - I2	1A - 20 mA			
Operation		Intermittent (at least one stop every 24 h)			
<b>EMISSIONS</b>					
Sound pressure	dBA	75	77	78,5	83
Sound output	W	--			
CO Emission	mg/kWh	< 40			
NOx Emission	mg/kWh	< 130			
<b>APPROVAL</b>					
Directive		90/396 - 89/336 (2004/108) - 73/23 (2006/95) - 92/42 EC			
Conforming to		EN 676			
Certification		CE 0085AP0944	CE 0085AP0945	CE 0085AP0946	CE 0085AT0042

- (01) Centrifugal with reverse curve blades  
(02) Centrifugal with forward curve blades

**Reference conditions:**

Temperature: 20°C - Pressure: 1013,5 mbar - Altitude: 0 m a.s.l. - Noise measured at a distance of 1 meter.

## FIRING RATES

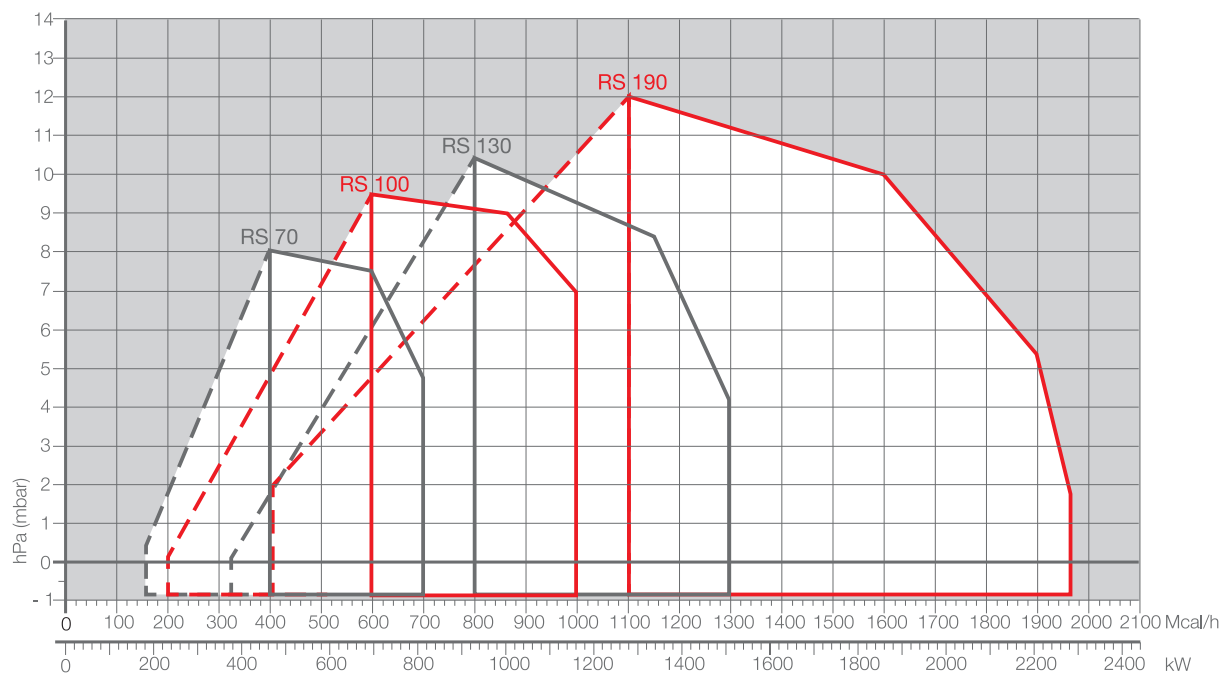
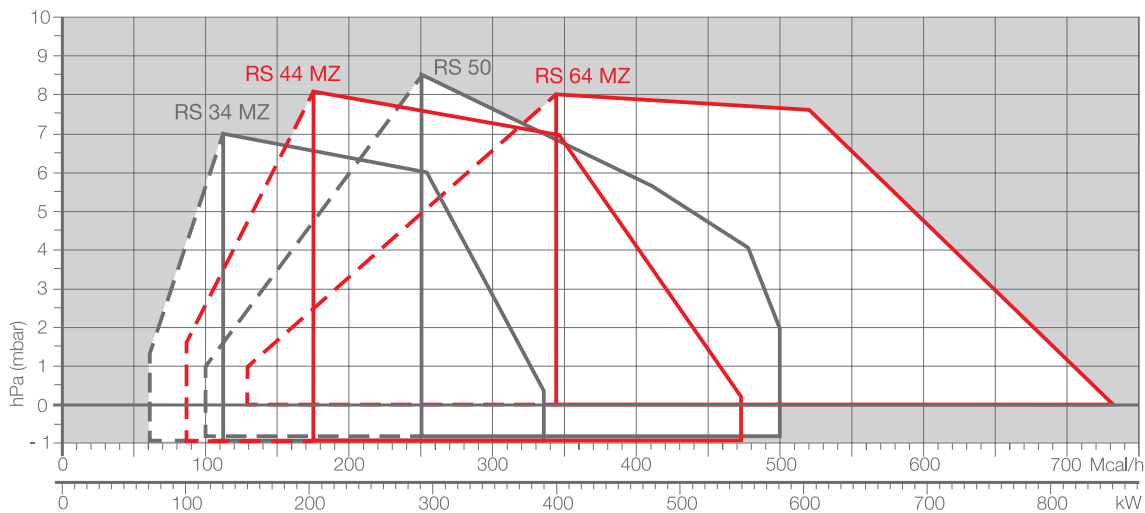

## GAS TRAINS

The burners are fitted with a butterfly valve to regulate the fuel delivery on 1<sup>st</sup> and 2<sup>nd</sup> stage, controlled by a variable profile cam servomotor.

Fuel can be supplied either from the right or left hand sides.

The gas train can be selected to best fit system requirements depending on the fuel output and pressure in the supply line.

The gas train can be “Multibloc” type (containing the main components in a single unit) or “Composed” type (assembly of the single components).

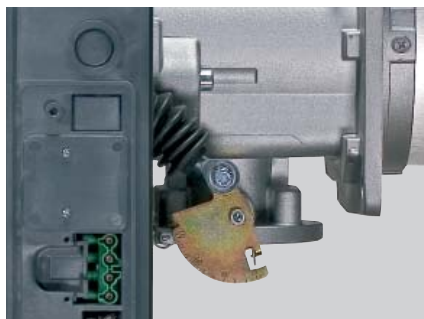

Example of the variable profile cam on RS 34-44 MZ burners.

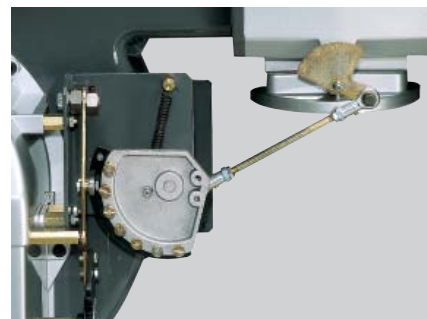

Example of the variable profile cam on RS 70-100-130 burners.

### MULTIBLOC gas train type MBD

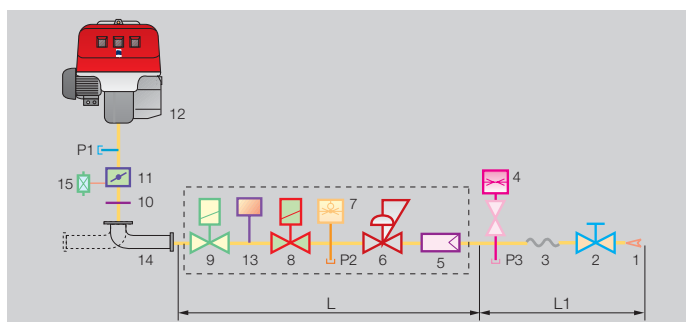

### MULTIBLOC gas train type MBC

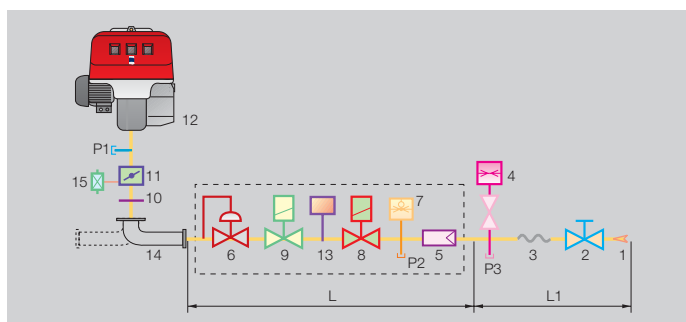

### COMPOSED gas train

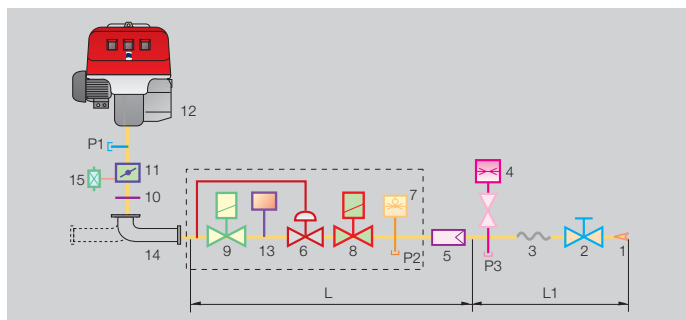

- |    |  |
|----|--|
| 1  | Gas input pipework   |
| 2  | Manual valve   |
| 3  | Anti-vibration joint   |
| 4  | Pressure gauge with pushbutton cock  |
| 5  | Filter   |
| 6  | Pressure regulator (vertical)  |
| 7  | Minimum gas pressure switch  |
| 8  | VS safety solenoid (vertical)  |
|    | VR regulation solenoid (vertical)  |
| 9  | Two settings: - firing output (rapid opening)<br>- maximum output (slow opening)   |
| 10 | Gasket and flange supplied with the burner   |
| 11 | Gas adjustment butterfly valve   |
| 12 | Burner   |
|    | Seal control mechanism for valves 8-9. According to standard EN 676, the seal control is compulsory for burners with maximum output above 1200 kW (in gas train with seal control) |
| 13 |  |
| 14 | Gas train-burner adapter   |
| 15 | Maximum gas pressure switch (present if installed as burner accessory)   |
| P1 | Combustion head pressure   |
| P2 | Pressure downstream from the regulator   |
| P3 | Pressure upstream from the filter  |
| L  | Gas train supplied separately, with the code given in the table  |
| L1 | Installer's responsibility   |

Gas trains are approved by standard EN 676 together with the burner.

The overall dimensions of the gas train depends on how they are constructed. The following table shows the maximum dimensions of the gas trains that can be fitted to RS/M burners, intake and outlet diameters and seal control if fitted.

Please note that the seal control can be installed as an accessory, if not already installed on the gas train.

The maximum gas pressure of gas train "Multibloc" type is 360 mbar, and that one of gas train "Composed" type is 500 mbar.

The range of pressure in the MULTIBLOC with flange can be modified choosing the stabiliser spring (see gas train accessory).

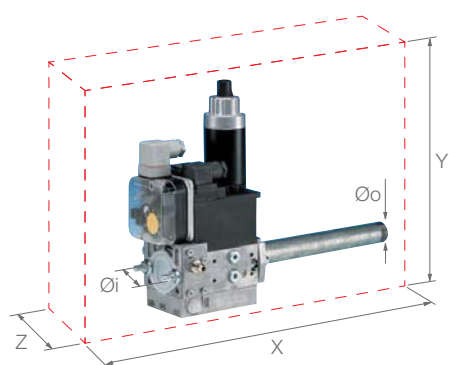

Example of gas train "MULTIBLOC" type MBD

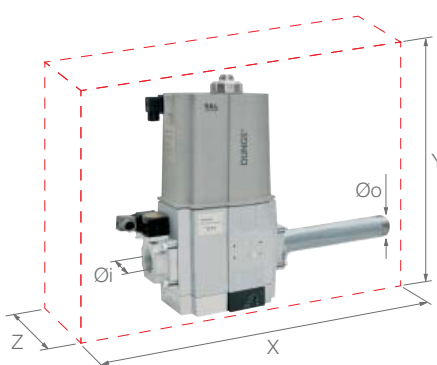

Example of gas train "MULTIBLOC" type MBC 1200

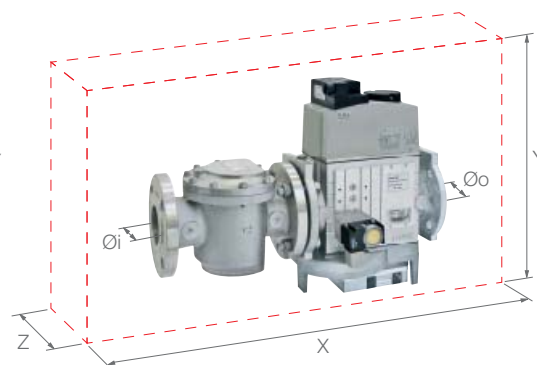

Example of gas train "COMPOSED" type MBC 1900 - 3100

	NAME	CODE	Ø I	Ø O	X mm	Y mm	Z mm	OUTPUT PRESSURE RANGE (mbar)	SEAL CONTROL
MULTIBLOC GAS TRAINS	MBD 405	3970500 (1) 3970553 (1)	3/4"	3/4"	371	186	120	4 - 20	Accessory
	MBD 407	3970229 (2) 3970599 (1)(3) 3970554 (1)	3/4"	3/4"	371	196	120	4 - 20	Accessory
	MBD 410	3970230 (2) 3970600 (1)(3) 3970144 (1)	1"	3/4"	405	217	145	4 - 20	Accessory
	MBD 412	3970231 (2) In progress (1)(3)	1"1/4	1"1/4	433	217	145	4 - 20	Accessory
	MBD 412 CT	3970197 (1) 3970180 (1)	1"1/4	1"1/4	433	217	262	4 - 20	Incorporated
	MBD 415	3970232 (2) 3970250 (1)(3)	1"1/2	1"1/2	523	250	100	4 - 33	Accessory
	MBD 415 CT	3970198 (1) 3970253 (1)(3)	1"1/2	1"1/2	523	250		4 - 33	Incorporated
	MBD 420	3970181 (1) 3970233 (2) 3970182 (1)	2"	2"	523	300		4 - 33	Accessory
	MBD 420 CT	3970234 (2) 3970252 (1)(3)	2"	2"	523	300	227	4 - 33	Incorporated
	MBC 1200 SE 50	3970221 (2)	2"	2"	573	425	161	4 - 60	Accessory
MBC 1200 SE 50 CT	3970225 (2)	2"	2"	573	425	288	4 - 60	Incorporated	
COMPOSED GAS TRAINS	MBC 1900 SE 65 FC	3970222 (2)	DN 65	DN 65	583	430	237	20 - 40	Accessory
	MBC 1900 SE 65 FC CT	3970226 (2)	DN 65	DN 65	583	430	364	20 - 40	Incorporated
	MBC 3100 SE 80 FC	3970223 (2)	DN 80	DN 80	633	500	240	20 - 40	Accessory
	MBC 3100 SE 80 FC CT	3970227 (2)	DN 80	DN 80	633	500	367	20 - 40	Incorporated

(1) Gas Train with 6-pin plug to install for connection to the burner.

(2) Gas Train with 6-pin plug installed for connection to the burner.

(3) Gas Train S52 type for application with high combustion head pressure drop.

## PRESSURE DROP DIAGRAM

The diagrams indicate the minimum pressure drop of the burners with the various gas trains that can be matched with them; at the value of these pressure drop add the combustion chamber pressure. The value thus calculated represents the minimum required input pressure to the gas train.

### RS 34 MZ (NATURAL GAS)

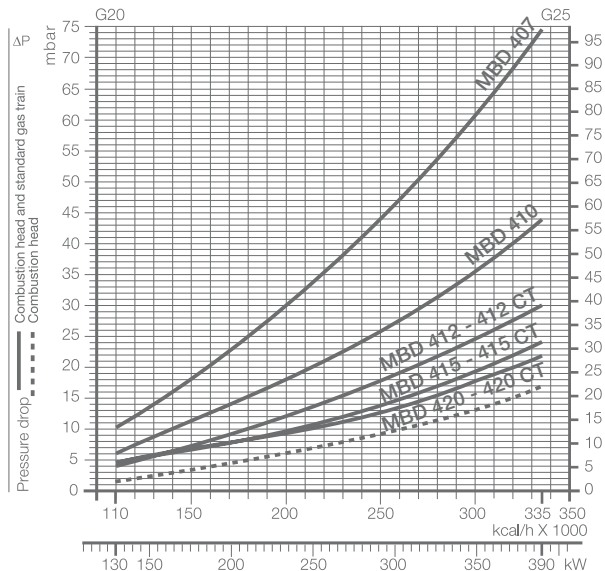

GAS TRAIN	CODE	ADAPTER	SEAL CONTROL
MBD 405	3970500 (1)	3000824	Accessory
	3970553 (1)	3000824	Accessory
	3970229 (2)	3000824	Accessory
MBD 407	3970599 (1)(3)	3000824	Accessory
	3970554 (1)	3000824	Accessory
MBD 410	3970230 (2)	3000824	Accessory
	3970600 (1)(3)	3000824	Accessory
	3970144 (1)	-	Accessory
MBD 412	3970231 (2)	-	Accessory

### RS 34 MZ (LPG)

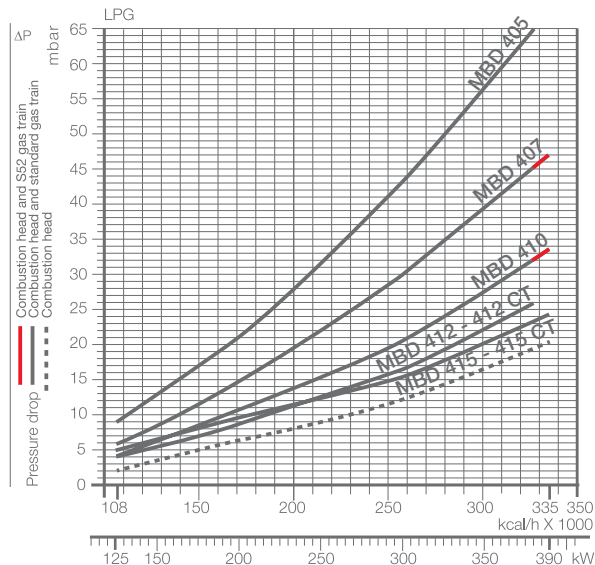

GAS TRAIN	CODE	ADAPTER	SEAL CONTROL
MBD 412 CT	3970197 (1)	-	Incorporated
MBD 415	3970180 (1)	-	Accessory
	3970232 (2)	-	Accessory
MBD 415 CT	3970198 (1)	-	Incorporated
MBD 420	3970181 (1)	3000822	Accessory
	3970233 (2)	3000822	Accessory
MBD 420 CT	3970182 (1)	3000822	Incorporated
	3970234 (2)	3000822	Incorporated

### RS 44 MZ (NATURAL GAS)

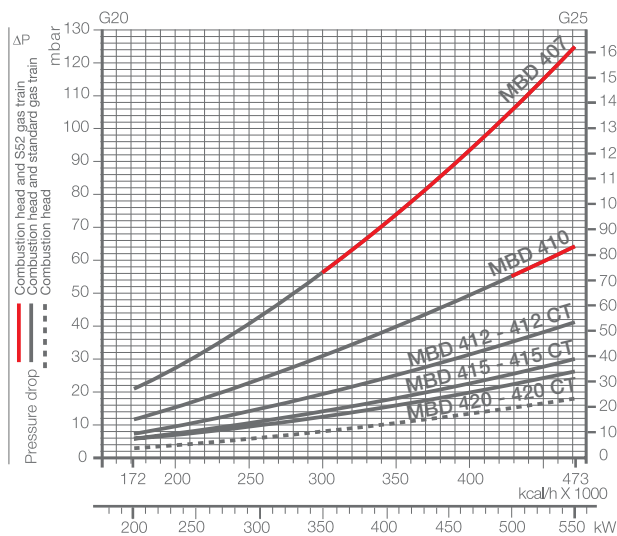

GAS TRAIN	CODE	ADAPTER	SEAL CONTROL
MBD 405	3970500 (1)	3000824	Accessory
	3970553 (1)	3000824	Accessory
	3970229 (2)	3000824	Accessory
MBD 407	3970599 (1)(3)	3000824	Accessory
	3970554 (1)	3000824	Accessory
MBD 410	3970230 (2)	3000824	Accessory
	3970600 (1)(3)	3000824	Accessory
	3970144 (1)	-	Accessory

### RS 44 MZ (LPG)

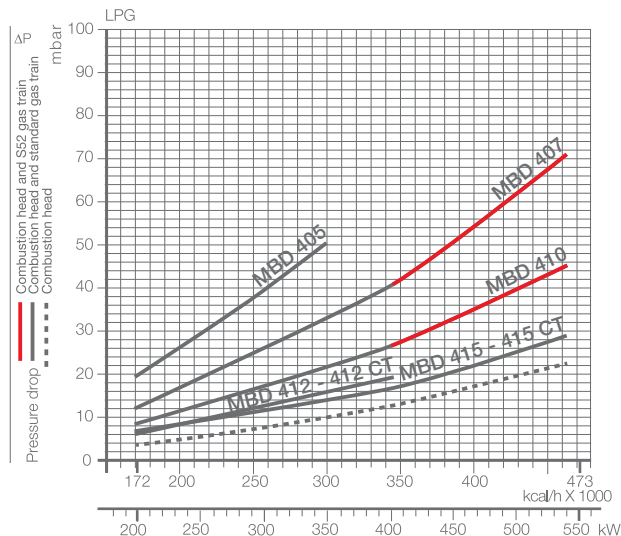

GAS TRAIN	CODE	ADAPTER	SEAL CONTROL
MBD 412	3970231 (2)	-	Accessory
MBD 412 CT	3970197 (1)	-	Incorporated
MBD 415	3970180 (1)	-	Accessory
	3970232 (2)	-	Accessory
MBD 415 CT	3970198 (1)	-	Incorporated
MBD 420	3970181 (1)	3000822	Accessory
	3970233 (2)	3000822	Accessory
MBD 420 CT	3970182 (1)	3000822	Incorporated
	3970234 (2)	3000822	Incorporated

(1) Gas Train with 6-pin plug to install for connection to the burner.  
 (2) Gas Train with 6-pin plug installed for connection to the burner.

(3) Gas Train S52 type for application with high combustion head pressure drop.



## RS 50 (NATURAL GAS)

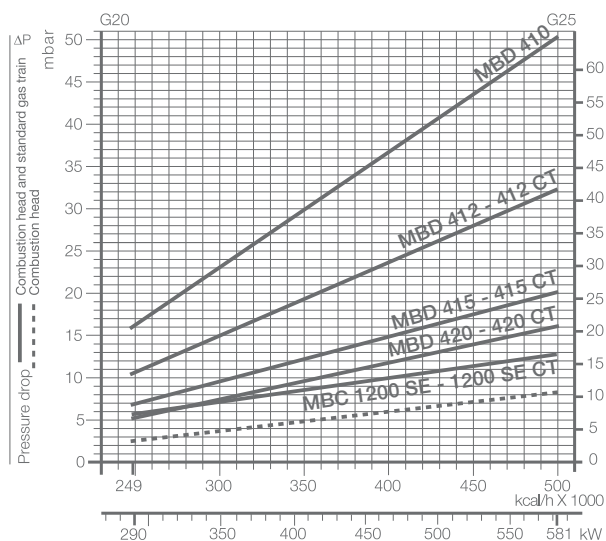

GAS TRAIN	CODE	ADAPTER	SEAL CONTROL
MBD 407	3970553 (1)	3000824	Accessory
	3970599 (1)(3)	3000824	Accessory
MBD 410	3970554 (1)	3000824	Accessory
	3970600 (1)(3)	3000824	Accessory
MBD 412	3970144 (1)	-	Accessory
	In progress (1)(3)	-	Accessory
MBD 412 CT	3970197 (1)	-	Incorporated
MBD 415	3970180 (1)	-	Accessory
	3970250 (1)(3)	-	Accessory

## RS 50 (LPG)

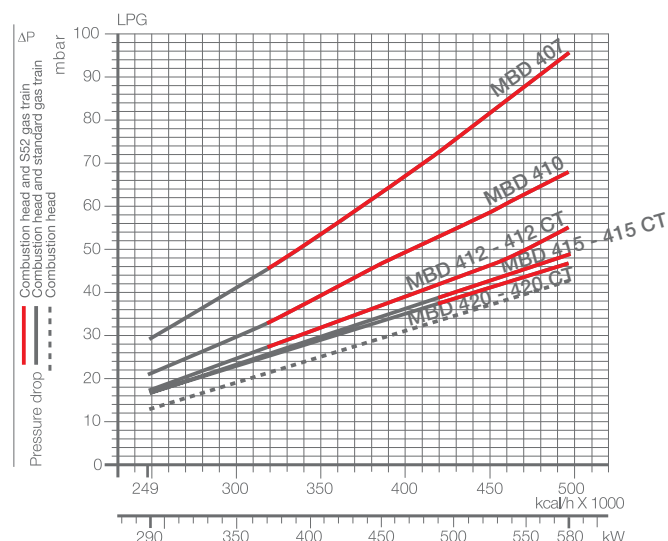

GAS TRAIN	CODE	ADAPTER	SEAL CONTROL
MBD 415 CT	3970198 (1)	-	Incorporated
	3970253 (1)(3)	-	Incorporated
MBD 420	3970181(1)	3000822	Accessory
MBD 420 CT	3970182(1)	3000822	Incorporated
	3970252 (1)(3)	3000822	Incorporated
MBC 1200 SE	3970221(2)	3000822	Accessory
MBC 1200 SE CT	3970225(2)	3000822	Incorporated

## RS 64 MZ (NATURAL GAS)

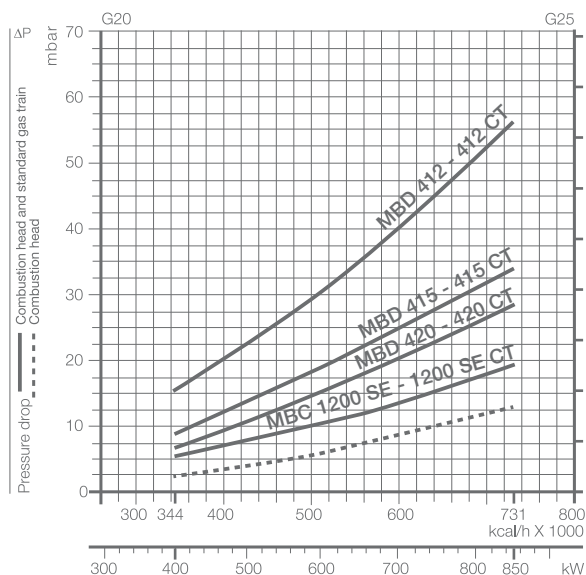

GAS TRAIN	CODE	ADAPTER	SEAL CONTROL
MBD 407	3970553 (1)	3000824+	Accessory
	3970599 (1)(3)	3000843	
MBD 410	3970554 (1)	3000824+	Accessory
		3000843	
MBD 412	3970144 (1)	3000843	Accessory
MBD 412 CT	3970197 (1)	3000843	Incorporated
MBD 415	3970180 (1)	3000843	Accessory

## RS 64 MZ (LPG)

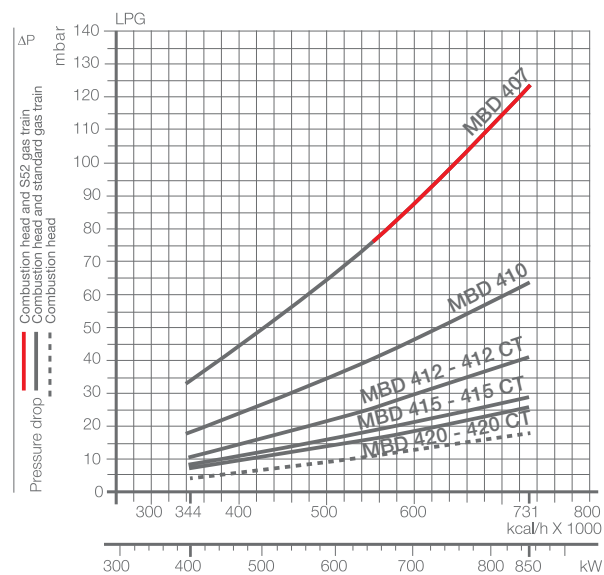

GAS TRAIN	CODE	ADAPTER	SEAL CONTROL
MBD 415 CT	3970198 (1)	3000843	Incorporated
MBD 420	3970181 (1)	-	Accessory
MBD 420 CT	3970182 (1)	-	Incorporated
MBC 1200 SE	3970221 (2)	-	Accessory
MBC 1200 SE CT	3970225 (2)	-	Incorporated

(1) Gas Train with 6-pin plug to install for connection to the burner.  
 (2) Gas Train with 6-pin plug installed for connection to the burner.

(3) Gas Train S52 type for application with high combustion head pressure drop.



### RS 70 (NATURAL GAS)

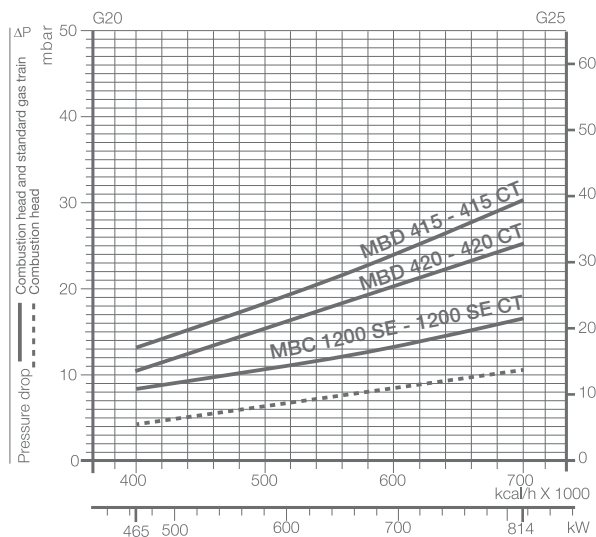

GAS TRAIN	CODE	ADAPTER	SEAL CONTROL
MBD 412	3970144	-	Accessory
MBD 412 CT	3970197	-	Incorporated
MBD 415	3970180	3000843	Accessory
MBD 415 CT	3970198	3000843	Incorporated

### RS 70 (LPG)

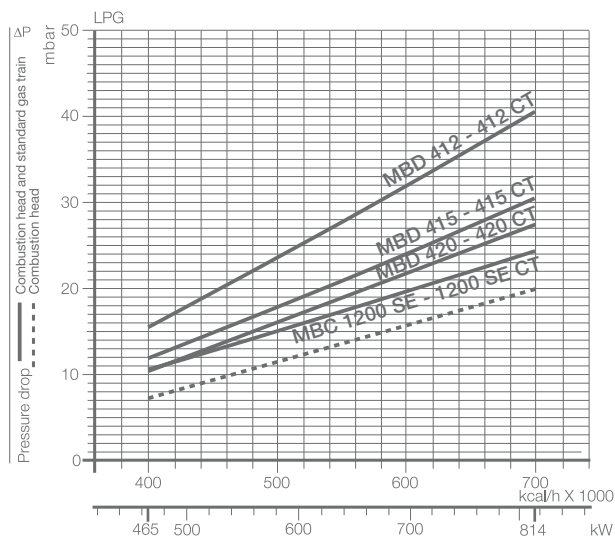

GAS TRAIN	CODE	ADAPTER	SEAL CONTROL
MBD 420	3970181	-	Accessory
MBD 420 CT	3970182	-	Incorporated
MBC 1200 SE	3970221	-	Accessory
MBC 1200 SE CT	3970225	-	Incorporated

### RS 100 (NATURAL GAS)

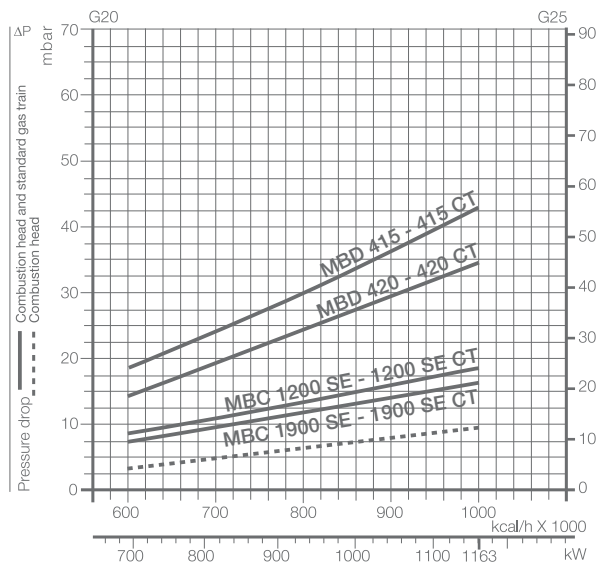

GAS TRAIN	CODE	ADAPTER	SEAL CONTROL
MBD 415	3970180	3000843	Accessory
MBD 415 CT	3970198	3000843	Incorporated
MBD 420	3970181	-	Accessory
MBD 420 CT	3970182	-	Incorporated

### RS 100 (LPG)

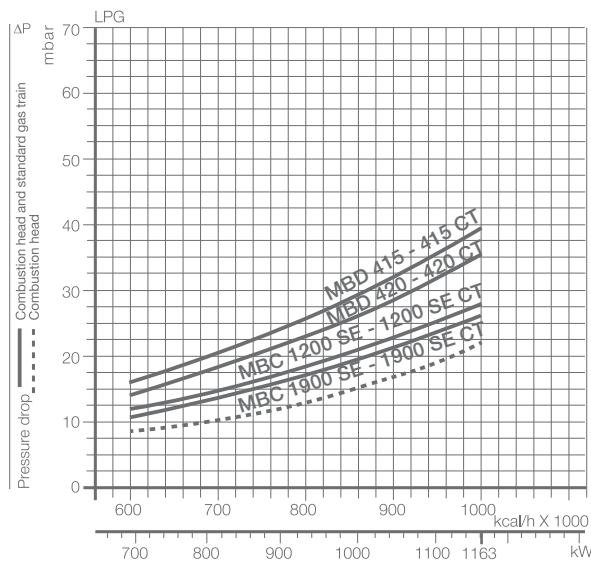

GAS TRAIN	CODE	ADAPTER	SEAL CONTROL
MBC 1200 SE	3970221	-	Accessory
MBC 1200 SE CT	3970225	-	Incorporated
MBC 1900 SE	3970222	3000825	Accessory
MBC 1900 SE CT	3970226	3000825	Incorporated

## RS 130 (NATURAL GAS)

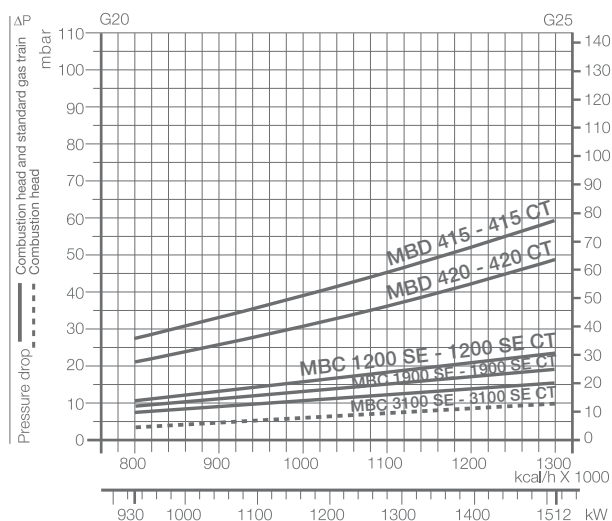

GAS TRAIN	CODE	ADAPTER	SEAL CONTROL
MBD 415	3970180	3000843	Accessory
MBD 415 CT	3970198	3000843	Incorporated
MBD 420	3970181	-	Accessory
MBD 420 CT	3970182	-	Incorporated
MBC 1200 SE	3970221	-	Accessory

## RS 130 (LPG)

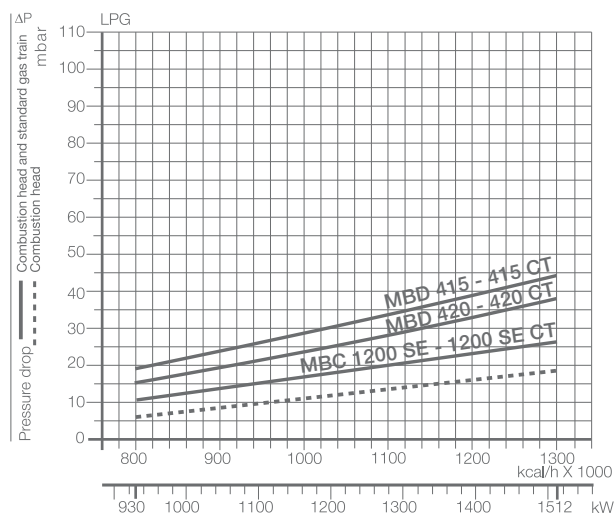

GAS TRAIN	CODE	ADAPTER	SEAL CONTROL
MBC 1200 SE CT	3970225	-	Incorporated
MBC 1900 SE	3970222	3000825	Accessory
MBC 1900 SE CT	3970226	3000825	Incorporated
MBC 3100 SE	3970223	3000826	Accessory
MBC 3100 SE CT	3970227	3000826	Incorporated

## RS 190 (NATURAL GAS)

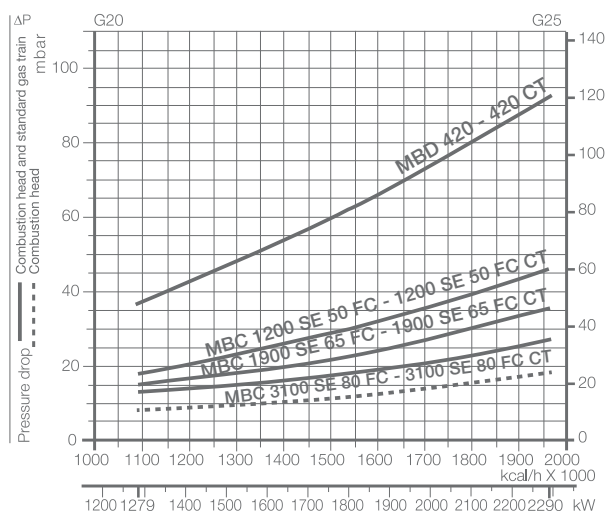

GAS TRAIN	CODE	ADAPTER	SEAL CONTROL
MBD 415	3970180	3000843	Accessory
MBD 415 CT	3970198	3000843	Incorporated
MBD 420	3970181	-	Accessory
MBD 420 CT	3970182	-	Incorporated
MBC 1200 SE 50	3970221	-	Accessory

## RS 190 (LPG)

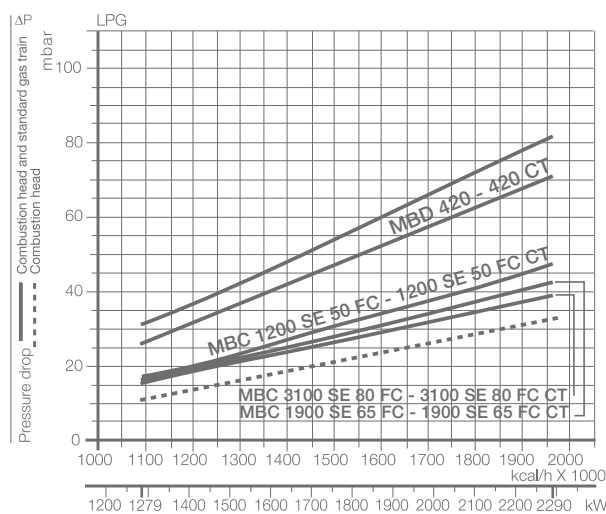

GAS TRAIN	CODE	ADAPTER	SEAL CONTROL
MBC 1200 SE 50 CT	3970225	-	Incorporated
MBC 1900 SE 65 FC	3970222	3000825	Accessory
MBC 1900 SE 65 FC CT	3970226	3000825	Incorporated
MBC 3100 SE 80 FC	3970223	3000826	Accessory
MBC 3100 SE 80 FC CT	3970227	3000826	Incorporated

Please contact the Riello Burner Technical Office for different pressure levels from those above indicated and refer to the technical manual for the correct choice of the spring.

In LPG plants, Multibloc gas trains do not operate below 0°C. They are only suitable for gaseous LPG (liquid hydrocarbons destroy the seal materials).

MBC 1200 gas train: the minimum operating pressure (\*) is higher or equal to 10 mbar. The gas train has to be installed next to the burner (if needed, only with the adapters listed in the catalogue) and it has to operate in its own working field.

MBC 1900-3100 gas train: the minimum operating pressure (\*) is higher or equal to 15 mbar. The gas train has to be installed next to the burner (if needed, with the adapters listed in the catalogue) and it has to operate in its own working field.

(\*) it is the upstream gas train pressure in full load operation conditions.

## SELECTING THE FUEL SUPPLY LINES

The following diagram enables pressure drop in a pre-existing gas line to be calculated and to select the correct gas train.

The diagram can also be used to select a new gas line when fuel output and pipe length are known. The pipe diameter is selected on the basis of the desired pressure drop. The diagram uses methane gas as reference; if another gas is used, conversion coefficient and a simple formula (on the diagram) transform the gas output to a methane equivalent (refer to figure A). Please note that the gas train dimensions must take into account the back pressure of the combustion chamber during operations.

### Control of the pressure drop in an existing gas line or selecting a new gas supply line.

The methane output equivalent is determined by the formula fig. A on the diagram and the conversion coefficient.

Once the equivalent output has been determined on the delivery scale ( $\dot{V}$ ), shown at the top of the diagram, move vertically downwards until you cross the line that represents the pipe diameter; at this point, move horizontally to the left until you meet the line that represents the pipe length.

Once this point is established you can verify, by moving vertically downwards, the pipe pressure drop of on the bottom scale below (mbar).

By subtracting this value from the pressure measured on the gas

meter, the correct pressure value will be found for the choice of gas train.

**Example:**

- gas used	G25
- gas output	9.51 mc/h
- pressure at the gas meter	20 mbar
- gas line length	15 m
- conversion coefficient	0.62 (see figure A)

- equivalent methane output  $\dot{V} = \left[ \begin{array}{l} 9.51 \\ 0.62 \end{array} \right] = 15.34 \text{ mc/h}$

- once the value of 15.34 has been identified on the output scale ( $\dot{V}$ ), moving vertically downwards you cross the line that represents 1" 1/4 (the chosen diameter for the piping);
- from this point, move horizontally to the left until you meet the line that represents the length of 15 m of the piping;
- move vertically downwards to determine a value of 1.4 mbar in the pressure drop bottom scale;
- subtract the determined pressure drop from the meter pressure, the correct pressure level will be found for the choice of gas train;

- correct pressure = ( 20-1.4 ) = 18.6 mbar

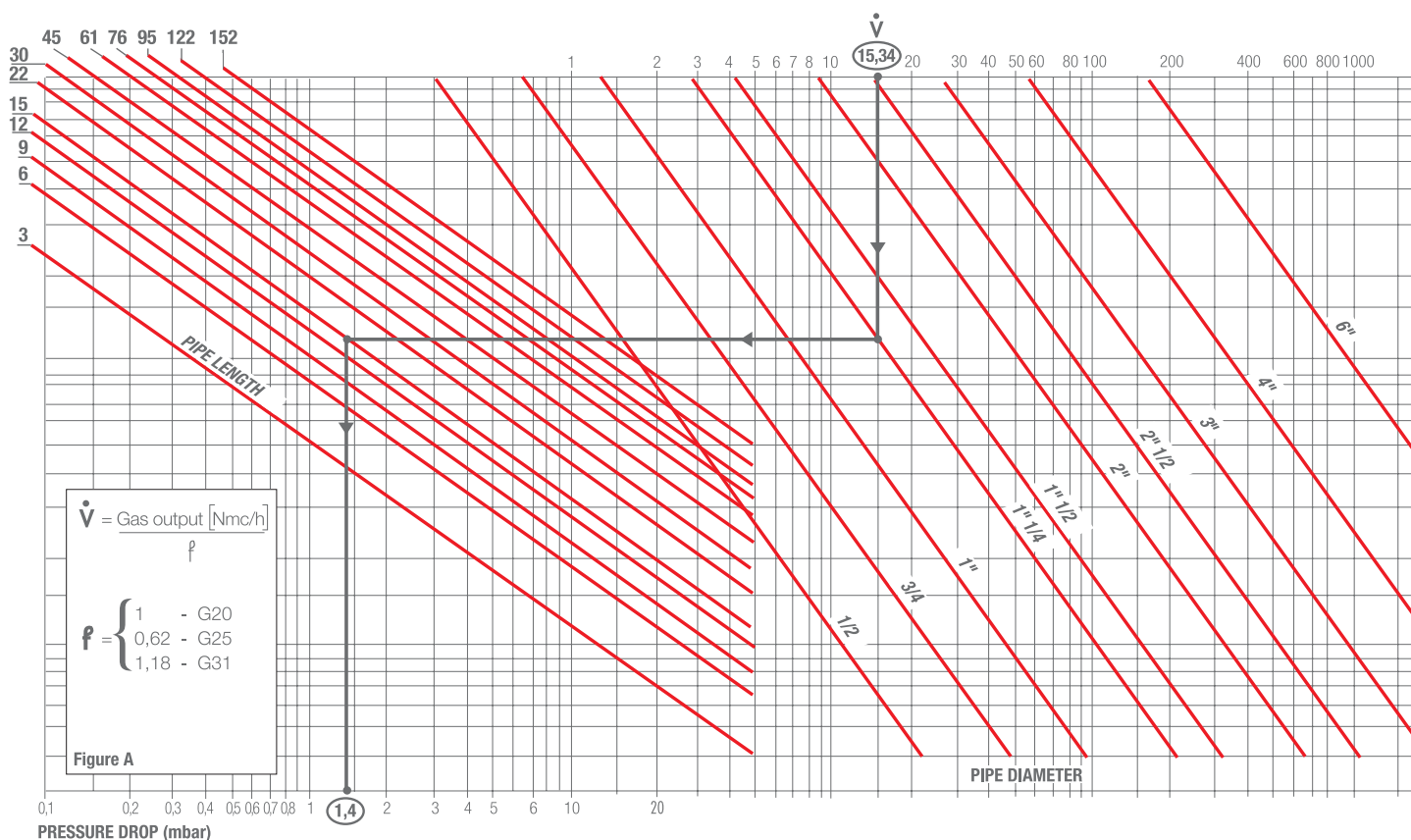

## Ventilation

The ventilation circuit produces low noise levels with high performance pressure and air output, inspite of the compact dimensions.

In the RS 34 MZ - 44 MZ - 64 MZ - 190 models, noise has been reduced by the special design of the air suction circuit. On RS 50-70-100-130 models, the use of reverse curve blades and sound-proofing material keeps noise level very low.

A variable profile cam connects the fuel and air regulations, to obtain a perfect control of combustion during the change of stage. When the burner is not operating the servomotor closes completely the air damper to reduce heat dispersion from the boiler.

A minimum air pressure switch stops the burner when there is an insufficient quantity of air at the combustion head.

The RS 34 MZ and RS 44 MZ are realised with a new structure made by an innovative technology based on a new fibreglass reinforced polyamide material, with high thermal and mechanical characteristics, instead of the traditional aluminium.

This allows big advantages in terms of lay-out rationalisation, weight and dimensions reduction.

In order to guarantee the correct exercise temperature for the internal burner components in every working conditions, the new structure includes an innovative patented cooling technology.

Between the burner front base and the reinforcing steel front plate, had been create an air cavity offering an high thermal insulation against the front boiler reflection heat, and to further improve the insulation efficiency the innovative **HCS (Housing Cooling System)** technology had been developed. Inside the front base cavity an air circulation is activated with continuous air volume refresh to obtain an active cooling system and avoid any heat transfer to the electrical component housing.



Example of HCS (Housing Cooling System) working concept.

# Combustion Head



Different lengths of the combustion head can be chosen for the RS series of burners.

The choice depends on the thickness of the front panel and the type of boiler.

Depending on the type of generator, check that the penetration of the head into the combustion chamber is correct.

The internal positioning of the combustion head can easily be adjusted to the maximum defined output by adjusting a screw fixed to the flange.



Example of a RS burner combustion head.

## DIMENSIONS OF THE FLAME

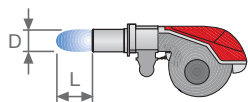

**Example:**  
 Burner thermal output = 2000 kW;  
 $L_{\text{flame}}$  (m) = 2,7 m (medium value);  
 $D_{\text{flame}}$  (m) = 0,8 m (medium value)

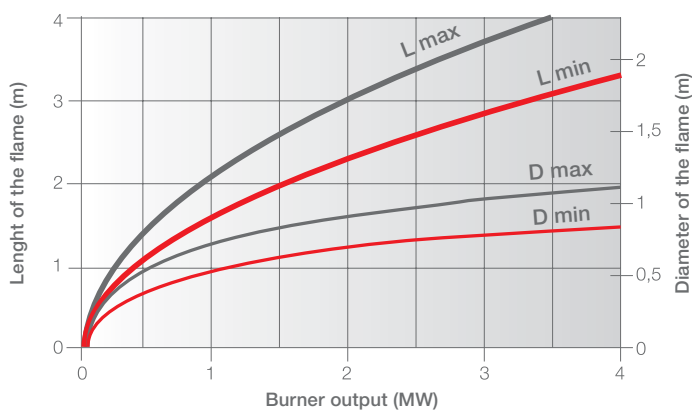



# Operation

## BURNER OPERATION MODE

On “two stage” operation, the burner gradually adapts the output to the requested level, by varying between two pre-set levels (see picture A).

### “TWO STAGE” OPERATION

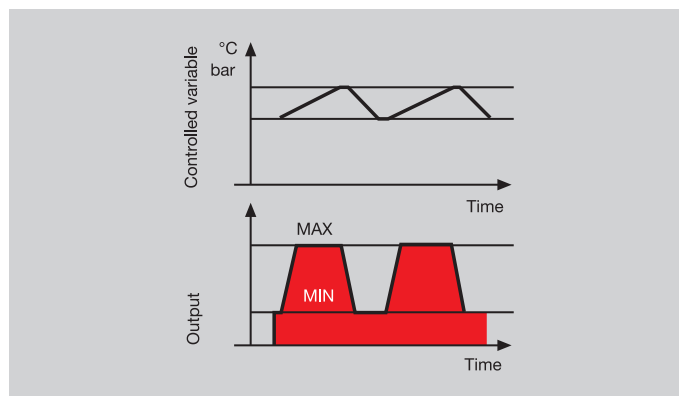

Picture A

All RS series burners are fitted with a new microprocessor control panel for the supervision during intermittent operation. For helping the commissioning and maintenance work, there are two main elements:



The lock-out reset button is the central **operating element** for resetting the burner control and for activating / deactivating the diagnostic functions.



The multi-color LED is the central **indication element** for visual diagnosis and interface diagnosis.

Both elements are located under the transparent cover of lock-out reset button, as showed below.



There are two diagnostic choices, for indication of operation and diagnosis of fault cause:

### VISUAL DIAGNOSIS



## INTERFACE DIAGNOSIS

By the interface adapter and a PC with dedicated software or by a predisposed flue gas analyzer (see paragraph accessories).

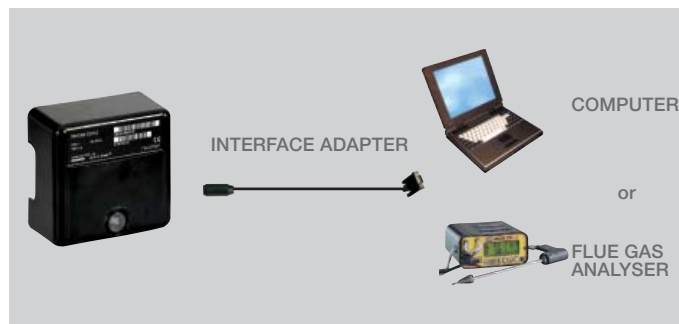

## INDICATION OF OPERATION

In normal operation, the various status are indicated in the form of colour codes according to the table below. The interface diagnosis (with adapter) can be activated by pressing the lock-out button for > 3 seconds.

COLOR CODE TABLE	
Operation status	Color code table
Stand-by	● ● ● ● ● ● ● ●
Pre-purging	● ● ● ● ● ● ● ●
Ignition phase	● ● ● ● ● ● ● ●
Flame OK	● ● ● ● ● ● ● ●
Poor flame	● ● ● ● ● ● ● ●
Undervoltage, built-in fuse	● ● ● ● ● ● ● ●
Fault, alarm	● ● ● ● ● ● ● ●
Flame simulation	● ● ● ● ● ● ● ●

● LED off

## DIAGNOSIS OF FAULT CAUSES

After lock-out has occurred, the red signal lamp is steady on. In this status, the visual fault diagnosis according to the error code table can be activated by pressing the lock-out reset button for > 3 seconds. The interface diagnosis (with adapter) can be activated by pressing again the lock-out button for > 3 seconds.

The flashing of red LED are a signal with this sequence:

(e.g. signal with n° 3 flashes – faulty air pressure monitor)



(● LED off)

## ERROR CODE TABLE

POSSIBLE CAUSE OF FAULT	FLASH CODE
No establishment of flame at the end of safety time:	● 2x flashes
Faulty air pressure monitor	● 3x flashes
Extraneous light or simulation of flame on burner start up	● 4x flashes
Loss of flame during operation:	● 7x flashes
Wiring error or internal fault	● 10x flashes



## START UP CYCLE

RS 34 MZ - 44 MZ - 50 - 64 MZ - 100 - 130 - 190

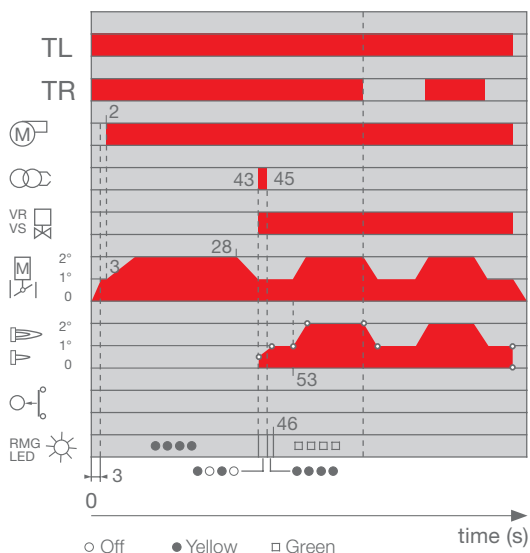

- 0 s The burner begins the firing cycle.
- 2 s The motor starts: pre-purge phase.
- 43 s Ignition electrode sparks; safety valve VS and adjustment valve VR open.
- 45 s The spark goes out.
- 53 s Output can be increased; start up cycle is concluded.

## Burner Wiring

All models of the RS burner series have an easily accessible control panel for the electrical components housing and wiring. In particular the RS 34-44 MZ models, thanks to the new structure concept, have a extremely clean electrical layout to optimise the commissioning and maintenance speed. On these models the electrical connection are done by a Plug&Socket system, accessible from the external of the cover, and some of the main components as the servomotor, the air pressure switch and the gas max pressure switch (accessory) are connected to the burner electrical wiring trough plugs & sockets system in order to facilitate the connection in case of maintenance. The electrical wiring of all RS burner models are very easy to do following the wiring diagrams included in the instruction handbook. Electrical connections must be made by qualified and skilled personnel, according to the local norms.

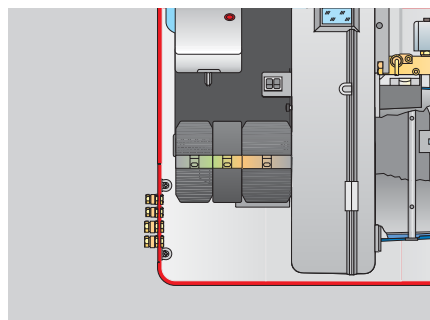

Example of plugs and sockets for electrical connections for the RS 50 model.

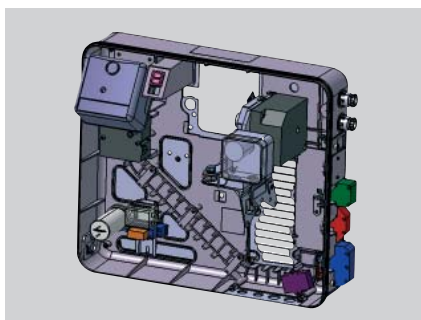

Example of electrical components housing and Plug&Socket system for electrical connection of RS 34-44 MZ.



The following table shows the supply lead sections and the type of fuse to be used.

MODEL	V	F (A)	L (mm <sup>2</sup> )
▶ RS 34 MZ	230	T6	1,5
▶ RS 44 MZ	230	T6	1,5
▶ RS 44 MZ	230	T6	1,5
	400	T6	1,5
▶ RS 50	230	T6	1,5
	400	T6	1,5
▶ RS 64 MZ	230	T10	1,5
	400	T6	1,5

MODEL	V	F (A)	L (mm <sup>2</sup> )
▶ RS 70	230	T10	1,5
	400	T6	1,5
▶ RS 100	230	T16	1,5
	400	T10	1,5
▶ RS 130	230	T16	1,5
	400	T10	1,5
▶ RS 190	230	T25	2,5
	400	T20	2,5

V = Electrical supply    F = Fuse    L = Lead section

## Emissions

The emission data has been measured in the various models at maximum output, according to EN 676 standard. The NOx emissions of RS 34-44-64 MZ models are conforming to the class 2 of EN 676.

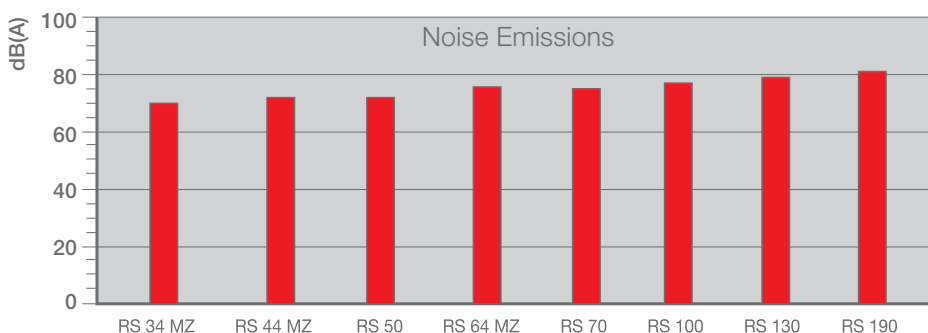
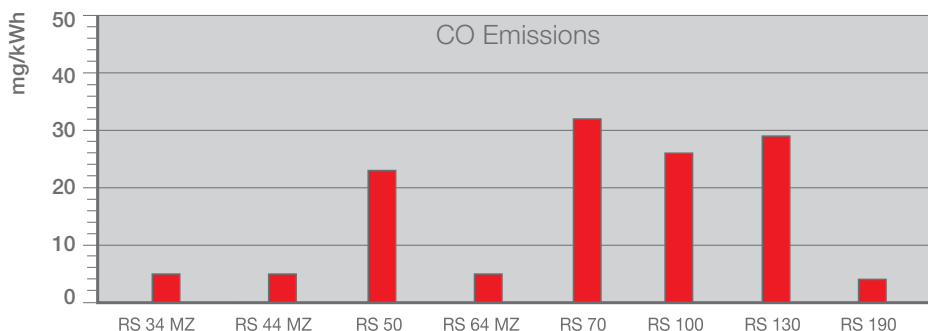
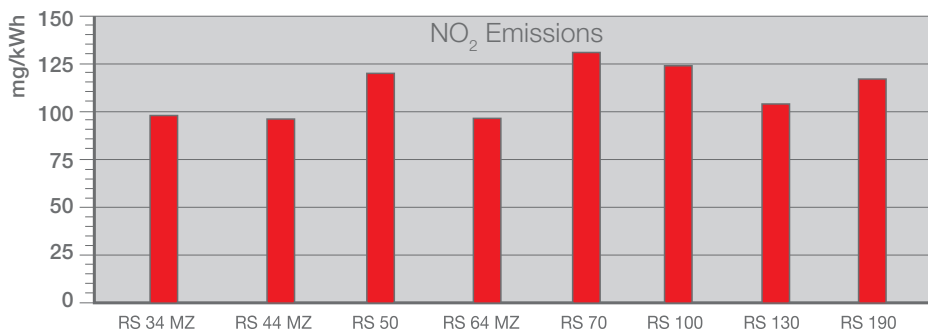

# Overall Dimensions (mm)

## BURNERS

RS 34 MZ - 44 MZ

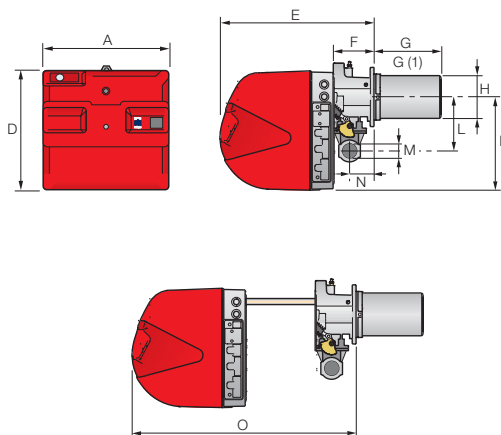

RS 50

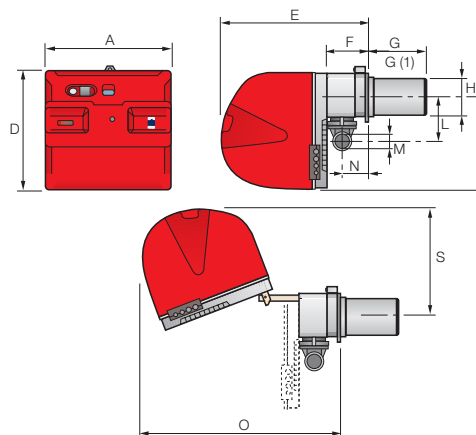

MODEL	A	D	E	F	G - G(1)	H	I	L	M	N	O	S
▶ RS 34 MZ	442	422	508	138	216 - 351	140	305	177	1 1/2"	84	780	-
▶ RS 44 MZ	442	422	508	138	216 - 351	152	305	177	1 1/2"	84	780	-
▶ RS 50	476	474	580	164	216 - 351	152	352	168	1 1/2"	108	810	367

(1) dimension with extended head

RS 64 MZ

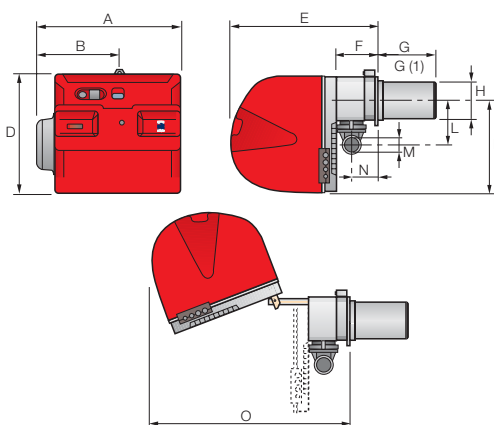

RS 70 - 100 - 130 - 190

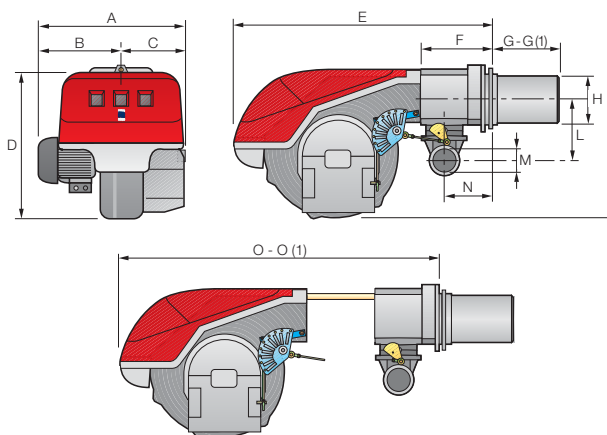

MODEL	A	B	C	D	E	F	G - G(1)	H	I	L	M	N	O - O(1)
▶ RS 64 MZ	533	300	-	490	640	222	250 - 385	179	352	221	2"	134	810 - -
▶ RS 70	511	296	215	555	840	214	250 - 385	179	430	221	2"	134	1161 - 1296
▶ RS 100	527	312	215	555	840	214	250 - 385	179	430	221	2"	134	1161 - 1296
▶ RS 130	553	338	215	555	840	214	280 - 415	189	430	221	2"	134	1161 - 1296
▶ RS 190	681	366	315	555	856	230	372 - 530	222	430	221	2"	150	1312 - -

(1) dimension with extended head

## BURNER - BOILER MOUNTING FLANGE

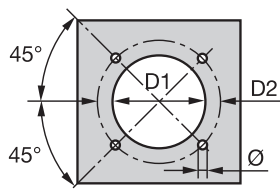

MODEL	D1	D2	Ø
▶ RS 34 MZ	160	224	M8
▶ RS 44 MZ	160	224	M8
▶ RS 50	160	224	M8
▶ RS 64 MZ	185	275-325	M12
▶ RS 70	185	275-325	M12
▶ RS 100	185	275-325	M12
▶ RS 130	195	275-325	M12
▶ RS 190	230	325-368	M16

## PACKAGING

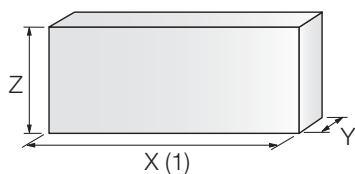

MODEL	X (1)	Y	Z	kg
▶ RS 34 MZ	1000	485	500	32
▶ RS 44 MZ	1000	485	500	33
▶ RS 50	1200	502	520	41
▶ RS 64 MZ	1200	580	520	42
▶ RS 70	1405	700	660	70
▶ RS 100	1405	700	660	73
▶ RS 130	1405	700	660	76
▶ RS 190	1405-1420	1000	660	82

(1) dimension with standard and extended head

## Installation Description

Installation, start up and maintenance must be carried out by qualified and skilled personnel. All operations must be performed in accordance with the technical handbook supplied with the burner.

### BURNER SETTING

All the burners have slide bars, for easier installation and maintenance.

After drilling the boilerplate, using the supplied gasket as a template, dismantle the blast tube from the burner and fix it to the boiler.

Adjust the combustion head.

Fit the gas train, choosing this on the basis of the maximum output of the boiler and considering the enclosed diagrams.

Refit the burner casing to the slide bars.

Close the burner, sliding it up to the flange.



### ELECTRICAL CONNECTIONS AND START UP

Make the electrical connections to the boiler following the wiring diagrams included in the instruction handbook.

Turn the motor to check rotation direction (if it is a three-phase motor).

Perform a first ignition calibration on the gas train.

On start up, check:

- Gas pressure at the combustion head (to max. and min. output)
- Combustion quality, in terms of unburned substances and excess air.



### BURNER MAINTENANCE

The maintenance of RS burners is very simple thanks to the sliding bars system that allows an easy access to the internal components.

In particular the RS 34-44 MZ models have a new sliding bars system to make easier the access to the combustion head.

The RS 190 has new reinforced sliding bars that make very strong the burner structure during maintenance.

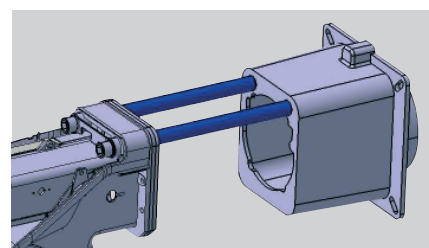



## Extended head kit

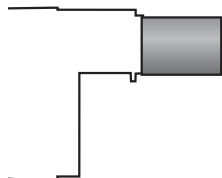

“Standard head” burners can be transformed into “extended head” versions, by using the special kit. The KITS available for the various burners, giving the original and the extended lengths, are listed below.

BURNER	'STANDARD HEAD' LENGTH (mm)	'EXTENDED HEAD' LENGTH (mm)	KIT CODE
▶ RS 34 MZ	216	351	3010428
▶ RS 44 MZ	216	351	3010429
▶ RS 50	216	351	3010078
▶ RS 64 MZ	250	385	3010427
▶ RS 70	250	385	3010117
▶ RS 100	250	385	3010118
▶ RS 130	280	415	3010119
▶ RS 190	372	530	3010443

## Spacer kit



If burner head penetration into the combustion chamber needs reducing, varying thickness spacers are available, as given in the following table:

BURNER	SPACER THICKNESS S (mm)	KIT CODE
▶ RS 34 MZ - 44 MZ - 50	90	3010095
▶ RS 64 MZ - 70 - 100 - 130	135	3010129
▶ RS 190	102	3000722

## Continuous ventilation kit



If the burner requires continuous ventilation in the stages without flame, a special kit is available as given in the following table:

BURNER	KIT CODE
▶ RS 34 MZ - 44 MZ	3010449
▶ RS 50 - 70 - 100 - 130 - 190	3010094

## Post-ventilation kit



To prolong ventilation after opening of thermostats chain, a special kit is available.

BURNER	POST-VENTILATION TIME (s)	KIT CODE
▶ RS 34 MZ - 44 MZ	5	3010004
▶ RS 50 - 70 - 100 - 130 - 190	20	3010452

## Connection flange kit

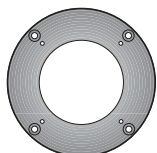

A kit is available for use where the burner opening on the boiler is of excessive diameter.

BURNER	KIT CODE
▶ RS 34 MZ - 44 MZ - 50	3010138

## Sound proofing box



If noise emission needs reducing even further, sound-proofing boxes are available, as given in the following table:

BURNER	BOX TYPE	AVERAGE NOISE REDUCTION [dB(A)](*)	BOX CODE
▶ RS 34 MZ - 44 MZ - RS 50 - RS 64 MZ	C1/3	10	3010403
▶ RS 70 - 100 - 130 - 190	C4/5	10	3010404

(\*) according to EN 15036-1 standard

## LPG kit



For burning LPG gas, a special kit is available to be fitted to the combustion head on the burner, as given in the following table:

BURNER	KIT CODE FOR 'STANDARD HEAD'	KIT CODE FOR 'EXTENDED HEAD'
▶ RS 34 MZ	3010423	3010423
▶ RS 44 MZ	3010424	3010424
▶ RS 50	3010165	3010165
▶ RS 64 MZ	3010434	3010435
▶ RS 70	3010097	3010098
▶ RS 100	3010099	3010100
▶ RS 130	3010101	3010102
▶ RS 190	3010166	3010166

## Town gas kit



For burning Town gas, a special kit is available:

BURNER	KIT CODE FOR 'STANDARD HEAD' (*)	KIT CODE FOR 'EXTENDED HEAD' (*)
▶ RS 34 MZ	in progress	in progress
▶ RS 44 MZ	in progress	in progress
▶ RS 50	3010285	3010285
▶ RS 70	3010286	3010286
▶ RS 100	3010287	3010287
▶ RS 130	3010288	3010288
▶ RS 190	3010297	3010297

(\*) Without CE certification



## Vibration reduction kit



The kit allow you to improve flame stability in some applications, where the boiler/flue assembly is liable to resonate.

BURNER	KIT CODE
▶ RS 50 TC - RS 50 TL	3010200
▶ RS 70 TC - RS 70 TL	3010201
▶ RS 100 TC - RS 100 TL	3010202
▶ RS 130 TC	3010373
▶ RS 130 TL	3010374
▶ RS 190 TC	3010375

## Status Panel kit



The RS burners can be equipped with an exclusive electronic device “Status Panel” which continuously monitors and displays all the burner operational modes and picks up any anomalies during the operational cycle.

BURNER	KIT CODE
▶ RS 50 - 64 MZ - 70 - 100 - 130 - 190	3010322

## Ground fault interrupter kit



A “Ground fault interrupter kit” is available as a safety device for electrical system fault.

BURNER	KIT CODE
▶ RS 34 MZ - 44 MZ	3010448
▶ RS 50 - RS 64 MZ	3010321
▶ RS 70 - 100 - 130 - 190	3010329

## Gas max pressure switch

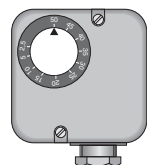

If necessary a Gas max pressure Switch kit is available and connectable to the burner electrical wiring trough Plugs & Sockets system.

BURNER	KIT CODE
▶ RS 34 MZ - 44 MZ	3010418

## Volt free contact kit



A volt free contact kit is available for installation onto the burner. It can be used for a remote interface between burner operating signals. Every burner can be equipped with a single kit for a remote check of the flame presence signal and the burner lockout indication.

BURNER	KIT CODE
▶ RS 34 MZ - 44 MZ - 64 MZ	3010419

## PC interface kit



To connect the flame control panel to a personal computer for the transmission of operation, fault signals and detailed service information, an interface adapter with PC software are available.

BURNER	KIT CODE
► RS 34 MZ - 44 MZ - 50 - 64 MZ - 70 - 100 - 130 - 190	3002719

## Hours counter kit

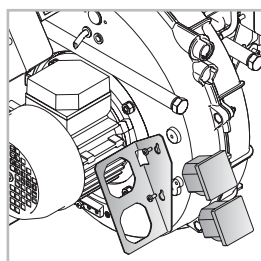

To measure the burner working time a hours counter kit is available.

BURNER	KIT CODE
► RS 34 MZ - 44 MZ	3010450

## DN80 gas flange kit

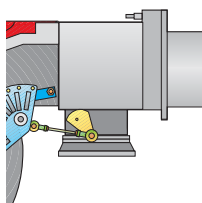

To modify the standard 2" burner gas input connection in to DN80 connection, a specific gas flange is available.







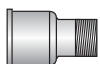











BURNER	KIT CODE
► RS 64 MZ - 70 - 100 - 130 - 190	3010439

# Gas Train Accessories

## Adapters



When the diameter of the gas train is different from the set diameter of the burners, an adapter must be fitted between the gas train and the burner. The following table lists the adapters for various burners.

BURNER	GAS TRAIN	DIMENSIONS	ADAPTER CODE
▶ RS 34 MZ	MBD 405 - 407 - 410	3/4"  1" 1/2	3000824
	MBD 420	2"  1" 1/2	3000822
▶ RS 44 MZ	MBD 405 - 407 - 410	3/4"  1" 1/2	3000824
	MBD 420	2"  1" 1/2	3000822
▶ RS 50	MBD 407 - 410	3/4"  1" 1/2	3000824
	MBD 420 - MBC 1200	2"  1" 1/2	3000822
▶ RS 64 MZ	MBD 407 - 410	3/4"  1" 1/2	3000824
		1" 1/2  2"	3000843
	MBD 412 - 415	1" 1/2  2"	3000843
▶ RS 70	MBC 1900	1" 1/2  2"	3000843
		DN 65  2" 1/2  2"	
	MBC 3100	DN 80  2" 1/2  2"	3000826
▶ RS 100	MBC 1900	1" 1/2  2"	3000843
		DN 65  2" 1/2  2"	
	MBC 3100	DN 80  2" 1/2  2"	3000826
▶ RS 130	MBC 1900	1" 1/2  2"	3000843
		DN 65  2" 1/2  2"	
	MBC 3100	DN 80  2" 1/2  2"	3000826
▶ RS 190	MBC 1900	1" 1/2  2"	3000843
		DN 65  2" 1/2  2"	
	MBC 3100	DN 80  2" 1/2  2"	3000826

## Seal control kit



To test the valve seals on the gas train, a special “seal control kit” is available. The valve seal control device is compulsory (EN 676) on gas trains to burners with a maximum output over 1200 kW. The sealing control is type VPS 504.

GAS TRAIN	KIT CODE
► MBD type	3010123
► MBC type	3010367

## Stabiliser spring



Accessory springs are available to vary the pressure range of the gas train stabilisers. The following table shows these accessories with their application range.

GAS TRAIN	SPRING	SPRING CODE
MBC 1900 ► MBC 3100 MBC 5000	White from 4 to 20 mbar	3010381
	Red from 20 to 40 mbar	3010382
	Black from 40 to 80 mbar	3010383
	Green from 80 to 150 mbar	3010384

Please refer to the technical manual for the correct choice of spring.

## DESIGNATION OF SERIES

A specific index guides your choice of burner from the various models available in the RS series. Below is a clear and detailed specification description of the product.

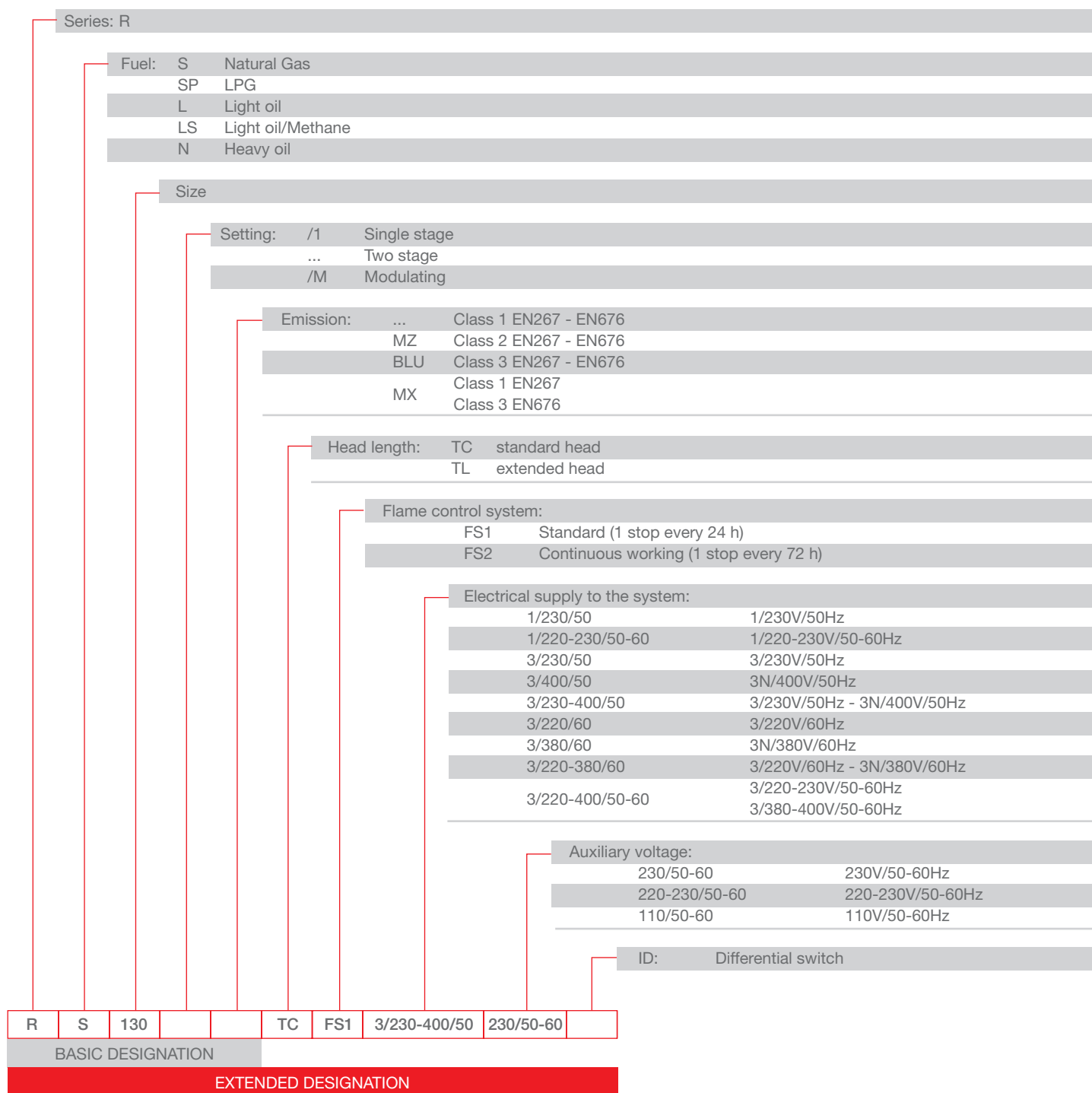

**AVAILABLE BURNER MODELS**

RS 34 MZ	TC	FS1	1/220-230/50-60	220-230/50-60
RS 34 MZ	TL	FS1	1/220-230/50-60	220-230/50-60
RS 44 MZ	TC	FS1	1/220-230/50-60	220-230/50-60
RS 44 MZ	TL	FS1	1/220-230/50-60	220-230/50-60
RS 44 MZ	TC	FS1	3/220-400/50-60	220-230/50-60
RS 44 MZ	TL	FS1	3/220-400/50-60	220-230/50-60
RS 50	TC	FS1	3/230-400/50	230/50-60
RS 50	TL	FS1	3/230-400/50	230/50-60
RS 50	TC	FS1	3/220-230/380-400/60	230/50-60
RS 50	TL	FS1	3/220-230/380-400/60	230/50-60
RS 50	TC	FS1	3/254-265/440-460/60	230/50-60
RS 50	TL	FS1	3/254-265/440-460/60	230/50-60
RS 64 MZ	TC	FS1	3/230-400/50	230/50-60
RS 64 MZ	TL	FS1	3/230-400/50	230/50-60
RS 70	TC	FS1	3/230-400/50	230/50-60
RS 70	TL	FS1	3/230-400/50	230/50-60
RS 70	TC	FS1	3/220-230/380-400/60	230/50-60
RS 70	TL	FS1	3/220-230/380-400/60	230/50-60
RS 70	TC	FS1	3/254-265/440-460/60	230/50-60
RS 70	TL	FS1	3/254-265/440-460/60	230/50-60
RS 100	TC	FS1	3/230-400/50	230/50-60
RS 100	TL	FS1	3/230-400/50	230/50-60
RS 100	TC	FS1	3/220-230/380-400/60	230/50-60
RS 100	TL	FS1	3/220-230/380-400/60	230/50-60
RS 100	TC	FS1	3/254-265/440-460/60	230/50-60
RS 100	TL	FS1	3/254-265/440-460/60	230/50-60
RS 130	TC	FS1	3/230-400/50	230/50-60
RS 130	TL	FS1	3/230-400/50	230/50-60
RS 130	TC	FS1	3/220-230/380-400/60	230/50-60
RS 130	TL	FS1	3/220-230/380-400/60	230/50-60
RS 130	TC	FS1	3/254-265/440-460/60	230/50-60
RS 130	TL	FS1	3/254-265/440-460/60	230/50-60
RS 190	TC	FS1	3/230-400/50	230/50-60
RS 190	TC	FS1	3/220-230/380-400/60	230/50-60
RS 190	TC	FS1	3/254-265/440-460/60	230/50-60

Other versions are available on request.

## PRODUCT SPECIFICATION

### RS 34 MZ - 44 MZ models

#### Burner

Monoblock forced draught gas burner with two stage operation, fully automatic, made up of:

- Air suction circuit
- High performance fan with straight blades
- Air damper for air flow setting and butterfly valve for regulating fuel output on 1<sup>st</sup> and 2<sup>nd</sup> stage controlled by a servomotor with variable cam
- Starting motor at 2800 rpm, single-phase / 220-230V / 50-60Hz or three-phase / 380-400V / 50-60Hz
- Combustion head, that can be set on the basis of required output, fitted with:
  - stainless steel end cone, resistant to corrosion and high temperatures
  - ignition electrodes
  - ionisation probe
  - gas distributor
  - flame stability disk
- Exclusive patented HCS (Housing Cooling System) with high thermal insulation and air circulation with continuous air volume refresh for an active cooling system and avoid heat transfer to the electrical component housing
- Minimum air pressure switch stops the burner in case of insufficient air quantity at the combustion head
- Microprocessor-based flame control panel, with diagnostic functions
- Plug and socket for electrical connections accessible from the external of the cover
- Burner on/off selection switch
- 1<sup>st</sup> - 2<sup>nd</sup> stage manual switch
- Flame inspection window
- Slide bars for easier installation and maintenance
- Protection filter against radio interference
- IP X0D (IP 40) electric protection level.

#### Gas train

Fuel supply line, in the MULTIBLOC configuration (from a diameter of 3/4" until a diameter 2") or COMPOSED configuration (from a diameter of DN 65 until a diameter of DN 100), fitted with:

- Filter
- Stabiliser
- Minimum gas pressure switch
- Safety valve
- Valve seal control (for output > 1200 kW)
- One stage working valve with ignition gas output regulator.

#### Conforming to:

- 89/336 (2004/108) EC directive (electromagnetic compatibility)
- 73/23 (2006/95) EC directive (low voltage)
- 92/42/EC directive (performance)
- 90/396/EC directive (gas)
- EN 676 (gas burners).

#### Standard equipment

- 1 gas train gasket
- 1 flange gasket
- 4 screws for fixing the flange
- 1 thermal screen
- 4 screws for fixing the burner flange to the boiler
- 3 plugs for electrical connection (RS 34 - 44 MZ single-phase)
- 4 plugs for electrical connection (RS 44 MZ three-phase)
- Instruction handbook for installation, use and maintenance
- Spare parts catalogue.

#### Available accessories to be ordered separately

- Extended head kit



- Spacer kit
- Continuous ventilation kit
- Post-ventilation kit
- Sound-proofing box
- LPG kit
- Ground fault interrupter kit
- Connection flange kit
- Gas max pressure switch
- Volt free contact kit
- PC interface kit
- Hours counter kit
- Gas train adapter
- Seal control kit.

## RS 50 - 64 MZ - 70 - 100 - 130 - 190 models

### Burner

Monoblock forced draught gas burner with two stage operation, fully automatic, made up of:

- Air suction circuit lined with sound-proofing material
- Fan with reverse curve blades (RS 50 - 70 - 100 - 130 models) or straight blades (RS 64 MZ - 190 models)
- Air damper for air flow setting and butterfly valve for regulating fuel output on 1<sup>st</sup> and 2<sup>nd</sup> stage controlled by a servomotor with variable cam
- Starting motor at 2800 rpm, three-phase 400V with neutral, 50Hz
- Combustion head, that can be set on the basis of required output, fitted with:
  - stainless steel end cone, resistant to corrosion and high temperatures
  - ignition electrodes
  - ionisation probe
  - gas distributor
  - flame stability disk
- Minimum air pressure switch stops the burner in case of insufficient air quantity at the combustion head
- Microprocessor-based flame control panel, with diagnostic functions
- Plug and socket for electrical connections (RS 50 models)
- Burner on/off selection switch
- 1<sup>st</sup> - 2<sup>nd</sup> stage manual switch
- Flame inspection window
- Slide bars for easier installation and maintenance
- Protection filter against radio interference
- IP 44 electric protection level.

### Gas train

Fuel supply line, in the MULTIBLOC configuration (from a diameter of 3/4" until a diameter 2") or COMPOSED configuration (from a diameter of DN 65 until a diameter of DN 100), fitted with:

- Filter
- Stabiliser
- Minimum gas pressure switch
- Safety valve
- Valve seal control (for output > 1200 kW)
- One stage working valve with ignition gas output regulator.

### Conforming to:

- 89/336 (2004/108) EC directive (electromagnetic compatibility)
- 73/23 (2006/95) EC directive (low voltage)
- 92/42/EC directive (performance)
- 90/396/EC directive (gas)
- EN 676 (gas burners).

#### Standard equipment

- 1 gas train gasket
- 1 flange gasket
- 4 screws for fixing the flange
- 1 thermal screen
- 4 screws for fixing the burner flange to the boiler
- Wiring loom fittings for the electrical connection (RS 50)
- 2 slide bar extensions (for extended head models and RS 190 model)
- Instruction handbook for installation, use and maintenance
- Spare parts catalogue.

#### Available accessories to be ordered separately

- Extended head kit
- Spacer kit
- Continuous ventilation kit
- Post-ventilation kit
- Sound-proofing box
- LPG kit
- Town gas kit
- Vibration reduction kit
- Status panel kit
- Ground fault interrupter kit
- Connection flange kit
- PC interface kit
- Gas train adapter
- Seal control kit
- Stabiliser spring.

**RIELLO** s.p.A.

Via Ing. Pilade Riello, 5  
37045 Legnago (VR) Italy

Tel. +39.0442.630111 - Fax +39.0442.21980

[www.rielloburners.com](http://www.rielloburners.com) - [info@rielloburners.com](mailto:info@rielloburners.com)

Since the Company is constantly engaged in the production improvement, the aesthetic and dimensional features, the technical data, the equipment and the accessories can be changed.  
This document contains confidential and proprietary information of RIELLO S.p.A. Unless authorised, this information shall not be divulged, nor duplicated in whole or in part.



Riello Burners is a brand of Riello Group.